



### 4.3.1 Institution frequently updates its IT facilities including Wi-Fi

Describe IT facilities including Wi-Fi with date and nature of updating within a maximum of 200 words

#### File Description

- Upload any additional information

Paste link for additional information

The institution has IT facilities including WI-FI and sufficient number of computers with required peripherals. The facility available facilitates ICT enabled teaching-learning process and evaluation, research activities, and administration. The departments are having system software and application software's, both licensed and open source software's. The following table describes the computing facility available:

<p><b>Internet and WI-FI facility:</b></p>	<p>Internet Facility Details:100 Mbps leased line          Content Ratio: 1:1(Gold)          (ISP provider –TATA Telecom),          Date of Updating: 01/09/2017          Aircell Backup line:10Mbps          Date: June 2017          Campus Wi-Fi available          Nature of Updating:48 Mbps to 200Mbps</p>
<p><b>System Software</b></p>	<p>Windows XP, Vista,7, 8, 8.1,10, Server          Ubuntu 14.04 (Open Source)          Fedora 19/20 (Open Source)          Windows Server 2008 R2 Standard</p>

	Windows Server 2008 R2 Enterprise 64-bit
<b>Application Software's(Licensed/Open Source)</b>	
<b>Mechanical Engineering</b>	CREO, ANSYS-6.0, MASTER CAM, CAD FEKO, Auto CAD, MATLAB 6.0  MATLAB Tool Boxes 5
<b>Computer Engineering&amp; Information Technology</b>	Exchange Server Standard Turbo C++ 4.5  Oracle 9i  Microsoft Visual Studio 2008, 2012, Express  Microsoft Office 2003/2007/2010/2013  Micro wind 3.1-comp  Adobe Flash MS Office 2013
<b>Electronics and Telecommunication Engg</b>	NI Multisim Circuit, Ladders Programming Triton, Xilinx , DSP Application Software, Embedded System Development software, Chips scope pro software, Proteus 11
<b>Electrical Engineering</b>	
<b>Accounts</b>	Tally ERP 9
<b>Library</b>	Auto-lib, Version 10

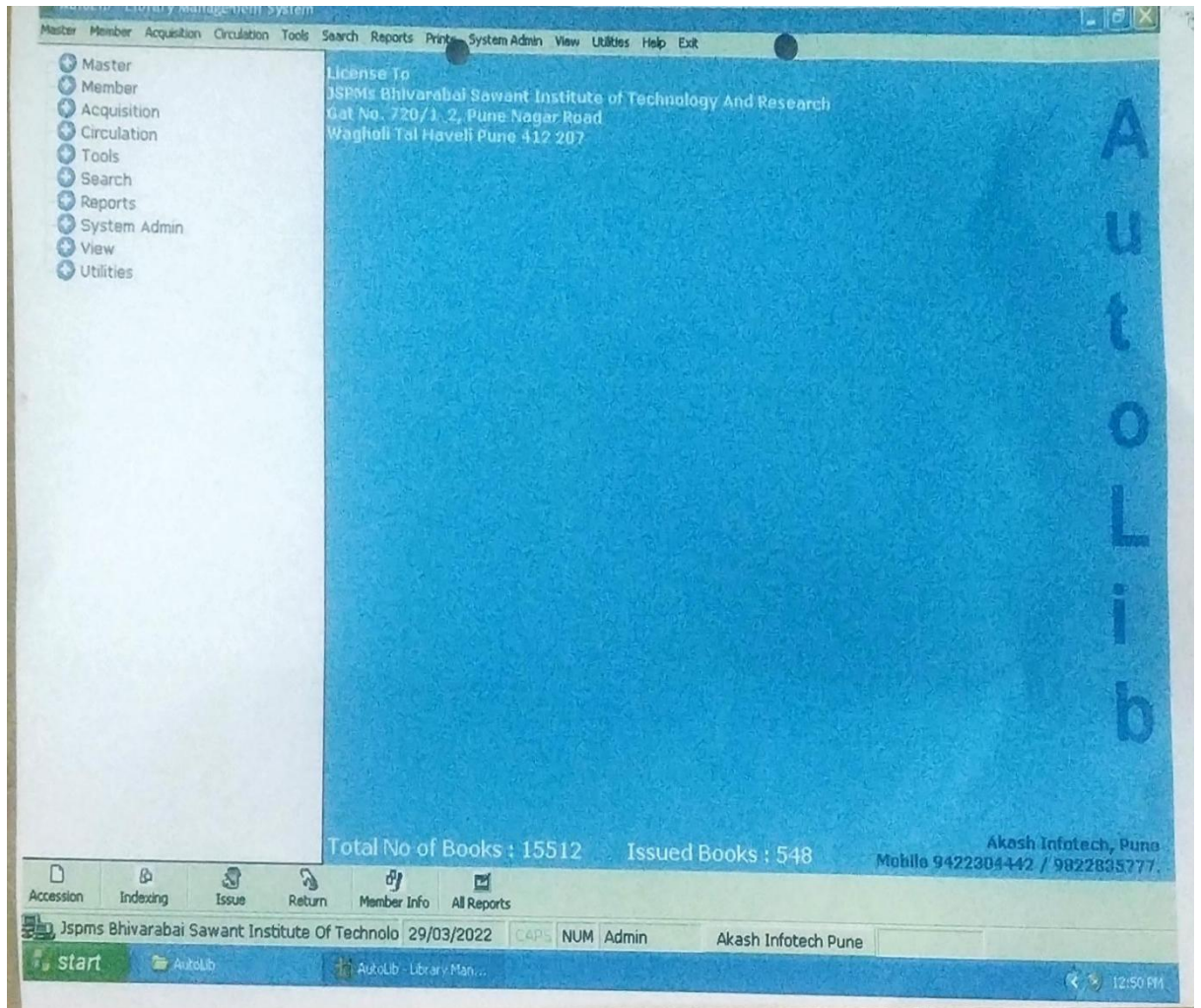

Auto lib library software

TOC UNIT 4 TEST 4 - Microsoft Excel

Timestamp	Total score	NAME OF STUDENT	ROLL NO	DIV
2021/09/23 10:05:05 AM GMT+5:30	0.00 / 30			
2021/10/11 11:15:18 AM GMT+5:30	24.00 / 30	Omkar Dambale	77 B	
2021/10/11 11:17:17 AM GMT+5:30	24.00 / 30	Nilesh Dnyaneshwar Gunji	22 B	
2021/10/11 11:18:35 AM GMT+5:30	21.00 / 30	Jitesh Waghmare	16 B	
2021/10/11 11:19:23 AM GMT+5:30	23.00 / 30	shubham nathu masalkar	43 a	
2021/10/11 11:19:46 AM GMT+5:30	26.00 / 30	Saloni KamalKishor Soni	36 B	
2021/10/11 11:20:25 AM GMT+5:30	24.00 / 30	Samruddhi Gamesh Kute	53 A	
2021/10/11 11:21:12 AM GMT+5:30	17.00 / 30	Sanket Machhindra Donga	38 B	
2021/10/11 11:21:28 AM GMT+5:30	29.00 / 30	Ilham Abubakkar Mulla	13 A	
2021/10/11 11:23:10 AM GMT+5:30	18.00 / 30	Sujit Gade	45 A	
2021/10/11 11:23:40 AM GMT+5:30	23.00 / 30	Shrushti Vijay Pathare	42 A	
2021/10/11 11:24:44 AM GMT+5:30	24.00 / 30	Anannya Kishor Kamble	4 A	
2021/10/11 11:25:28 AM GMT+5:30	24.00 / 30	Sumeet Laxman Suryawan	46 A	
2021/10/11 11:25:42 AM GMT+5:30	26.00 / 30	Manish Pankaj Saswadkar	16 A	
2021/10/11 11:25:57 AM GMT+5:30	27.00 / 30	Nilesh Neminath Patil	20 A	
2021/10/11 11:26:13 AM GMT+5:30	28.00 / 30	Gayatri Arvind Kale	12 B	
2021/10/11 11:26:16 AM GMT+5:30	23.00 / 30	Darshan Dattatray Gaikwad	57 B	
2021/10/11 11:26:18 AM GMT+5:30	27.00 / 30	Shreyas Kishor Kale	43 B	
2021/10/11 11:26:22 AM GMT+5:30	20.00 / 30	Shubham Shinde	69 A	
2021/10/11 11:26:22 AM GMT+5:30	27.00 / 30	Ashlesha Bachhav	7 A	
2021/10/11 11:26:22 AM GMT+5:30	28.00 / 30	Disha Gaikwad	10 B	
2021/10/11 11:26:26 AM GMT+5:30	21.00 / 30	Jayesh dambale	61 B	
2021/10/11 11:26:52 AM GMT+5:30	27.00 / 30	Himanshu Dhole	58 B	
2021/10/11 11:26:57 AM GMT+5:30	25.00 / 30	Harshada Pravin Yadav	52 A	

MOODLE -LMS - For examination analysis

Admission Enquiry

jspmsiotr.edu.in/Admission/66

JSPM's Bhivrabai Sawant Institute of Technology & Research, Wagholi, Pune

Gate No. 720/2, Nagar Road, Wagholi, Pune, Maharashtra 412207  
Approved by AICTE, New Delhi, Govt. Of Maharashtra & Affiliated To Savitribai Phule Pune University  
ACCREDITED BY NAAC WITH B++ GRADE

HOME ABOUT ADMISSION ACADEMICS PLACEMENTS CAMPUS-LIFE ACCREDITATION CONTACT MHT-CET **ADMISSION ENQUIRY**

# Admission Enquiry

Home - Admission Enquiry

**Know More**

- Admission Enquiry
- Admission Eligibility
- Programs Offered
- Admission FAQ's
- Documents Checklist
- Scholarships Available
- Fee Structure
- Apply For Provisional Admission

**Admission Form**

Name\*

Email\* Mobile\*

Aggregate Marks\*

City \*

Select Interested Branch Where Did You First Hear About Us

I'm not a robot

Administrative work through college website.

dbt MahaIT Workflow x Landing | Student Profile System x Inbox (451) - scholarship@jspmt: x +

dbtworkflow.mahaonline.gov.in/CollegeScrutinyDashBoard/Collegehomepage

Jayawant Shikshan Prasarak Mandal, Bhivarabai Sawant Institute of Technology & Research, Wagholi

Welcome, DT6311\_Principal Home

आपले सरकार महाDBT Scrutiny Portal

Welcome to Aaple Sarkar Direct Benefit Transfer Scrutiny Portal

\*All reports last updated on 07-04-2022 00:00:00

Select Department and Scheme For Scrutiny

Department Name \*  
---Select Department---

Scheme Name \*  
---Select Scheme---

Financial Year \*  
---Select Financial Year---

Select Scrutiny For \*  
---Select Installment---

Submit

Home

Scrutiny

Reports

- DBT Dashboard
- Allotment Date Wise Report
- Institute Disbursement Report
- Student Disbursement Report
- Status wise Application Detail Report

Institute

- Institute Profile
- Update Aadhaar Details
- Notifications
- Deactive Duplicate Aadhaar

Activate Windows  
Go to Settings to activate Windows.

Type here to search

32°C Sunny 10:20 07-04-2022

## Scholarship portal

examward.unipune.ac.in/ExamF X +

Not secure | examward.unipune.ac.in/ExamFormOnline/College/Default.aspx

SAVITRIBAI PHULE PUNE UNIVERSITY

Home

Dashboard

Exam Form Regular Inward Process

1. Inward

2. Create Transaction

3. Create Challan

Requests

Print Reports

User Manual

Welcome!!!

**Important instructions regarding Inward procedure**

- **Exam Form Regular Inward Process.** Student fill form, submit Exam Form and Fees to College. College will Inward form and Generate Transaction-Challan.
- Student can Fill online exam form by using their Student Profile.
- After filling Exam Form Student should inform filled Exam Form Number/Application Number to respective college.
- College will Inward given Exam Form Number/Application Number and then create Transactions & challans accordingly.

Follow the Instructions given below to Download College Side First Year Exam (Only Art/Science/Commerce) HallTicket data in CSV Format!!!

- 1) Select Print Reports and click on All-Reports option.
- 2) On All\_Reports Page first Select Exam Type as CollegeSide First Year Exam (Only Art/Science/Commerce).
- 3) Select Faculty And Course.
- 4) Select Report Type as Hall Ticket CSV For Student And Subject Details.
- 5) Only Challans Cleared (Amount Credited on University Account) list will be shown and from that list select Challan Number.
- 6) Click on Show Report button.
- 7) Select Option Students CSV File/Subjects CSV File and then click on Show Report button.
- 7) CSV Format file for selected option given for Download.

Follow the Instructions given below to Download College Side First Year Exam (Only Art/Science/Commerce) HallTicket data in Excel Format!!!



- 1) Select Print Reports and click on All-Reports option.
- 2) On All\_Reports Page first Select Exam Type as CollegeSide First Year Exam (Only Art/Science/Commerce).
- 3) Select Faculty And Course.
- 4) Select Report Type as Hall Ticket Excel For Student And Subject Details.
- 5) Only Challans Cleared (Amount Credited on University Account) list will be shown and from that list select Challan Number.

Windows taskbar: 11:26 AM 4/8/2022

## Savitribai Phule Pune Portal for Examination

Welcome to State Common Entrance Test Cell, Maharashtra State

cetcell.mahacet.org

Government of Maharashtra  
महाराष्ट्र शासन  
State Common Entrance Test Cell, Maharashtra State  
राज्य सामाईक प्रवेश परीक्षा कक्ष, महाराष्ट्र राज्य

VISIT CETCELL HOME  
CAP PORTAL A.Y.2020-21  
CAP PORTAL A.Y.2021-22

### CET Exam Portal For A.Y.2022-23

#### Notifications

New	2023.	
New	Tentative Schedule for All Common Entrance Tests A.Y. 2022-23	
New	LL.B-5 Yrs. CET Information Brochure A.Y.2022-23 (17-03-2022)	
New	PROPOSAL FOR SUBJECT EXPERT / PAPER SETTER / MODERATOR / CHIEF MODERATOR / TRANSLATOR FOR HIGHER EDUCATION CET -2022	
New	Notice No. 1: Higher Education CET- 2022	

**Technical Education**

**Post Graduate Courses**

- » MAH-MBA/MMS-CET 2022 New
- » MAH-MCA-CET 2022 New
- » MAH-M.Arch-CET 2022 New
- » MAH-M.HMCT CET 2022 New

**Under Graduate Courses**

- » MHT-CET 2022 (B.Engineering,B.Pharmacy,Agriculture Course Examination) New
- » MAH-B.HMCT/B.Planning-CET-2022

**Agriculture Education**

- » MHT-CET 2022 (B.Engineering,B.Pharmacy,Agriculture

**Higher Education**

**Post Graduate Courses**

- » MAH-B.Ed-M.Ed CET-2022 (Three Year Integrated Course) For Post Graduates in School Subject New
- » MAH-M.Ed CET-2022 New
- » MAH-M.P.Ed CET-2022 New

**Under Graduate Courses**

- » MAH- B.A/B.Sc.-B Ed CET-2022 (Four Year Integrated Course) For HSC (Arts/Science) Qualified Candidates New
- » MAH-LLB (5 Years) CET-2022 (Integrated Course) For SSC & HSC qualified Candidates New
- » MAH-LL.B(3Years) CET-2022 New

Type here to search

32°C Sunny 10:24 07-04-2022

CET Cell portal

Directorate of Technical Education X +

Not secure | dtemaharashtra.gov.in/index.html

महाराष्ट्र शासन उच्च व तंत्रशिक्षण विभाग  
GOVERNMENT OF MAHARASHTRA HIGHER & TECHNICAL EDUCATION DEPARTMENT

Search.. Skip to Main Content | A- A+ English Login

 Directorate of Technical Education, Maharashtra State  
तंत्रशिक्षण संचालनालय, महाराष्ट्र राज्य

 सत्यमेव जयते

Home About Us Desk's At DTE Scholarships Regional Directorate Admissions Downloads Important Links Media Corner

  
Shri. Uddhav Thackeray  
Honble  
Chief Minister

  
Shri. Uday Samant  
Honble Minister  
Higher & Technical Education

  
Shri. Prajakt Tanpure  
Honble Minister of State  
Higher & Technical Education

  
Shri. Vikas Chandra Rastogi  
Principal Secretary  
Higher & Technical Education

Announcements

Activate Windows  
Go to Settings to activate Windows.

Waiting for playg...

Type here to search

32°C Sunny 10:25 07-04-2022

DTE portal



Regional Office Pune, Maharashtra X +

ropune.org.in/ropune/indexnew.html

Select Language

महाराष्ट्र शासन  
Government of Maharashtra

उच्च व तंत्रशिक्षण विभाग  
Higher & Technical Education Department

A+ | A | A-

### Technical Education, Regional Office Pune

तंत्रशिक्षण विभागीय कार्यालय, पुणे

Home Login Circular Grievance Section E.S.T. Section(MIS) QUOTATIONS G.P.F Login Contact Us

विधी अधिकारी (Law Officer)जहिरात ( मुदतवाढ ) : अंतिम दिनांक २८ मार्च २०२२....

#### HOME



Shri Uddhav Thackeray  
Hon'ble  
Chief Minister



Shri. Uday Samant  
Hon'ble Minister  
Higher & Technical Education



Dr. Abhay Wagh  
Director  
Tech. Education Maharashtra

#### Circulars

Important : Public Notice : Approval Process 2022-23... (05/04/2022)

Urgent/ Important : Submission of TREE PLANTATION Information w.r.t. L.A.Q. no.21809. .... (04/04/2022)

Hearing regarding approval of admission.(31/03/2022)

सकल मराठी या फॉन्ट मध्ये माहिती सादर करणे (31/03/2022)

More Circular

#### Photo



Activate Windows  
Go to Settings to activate Windows.

Scholarship Admission 2021-22

Type here to search

32°C Sunny 10:26 07-04-2022

## DTE RO PUNE portal

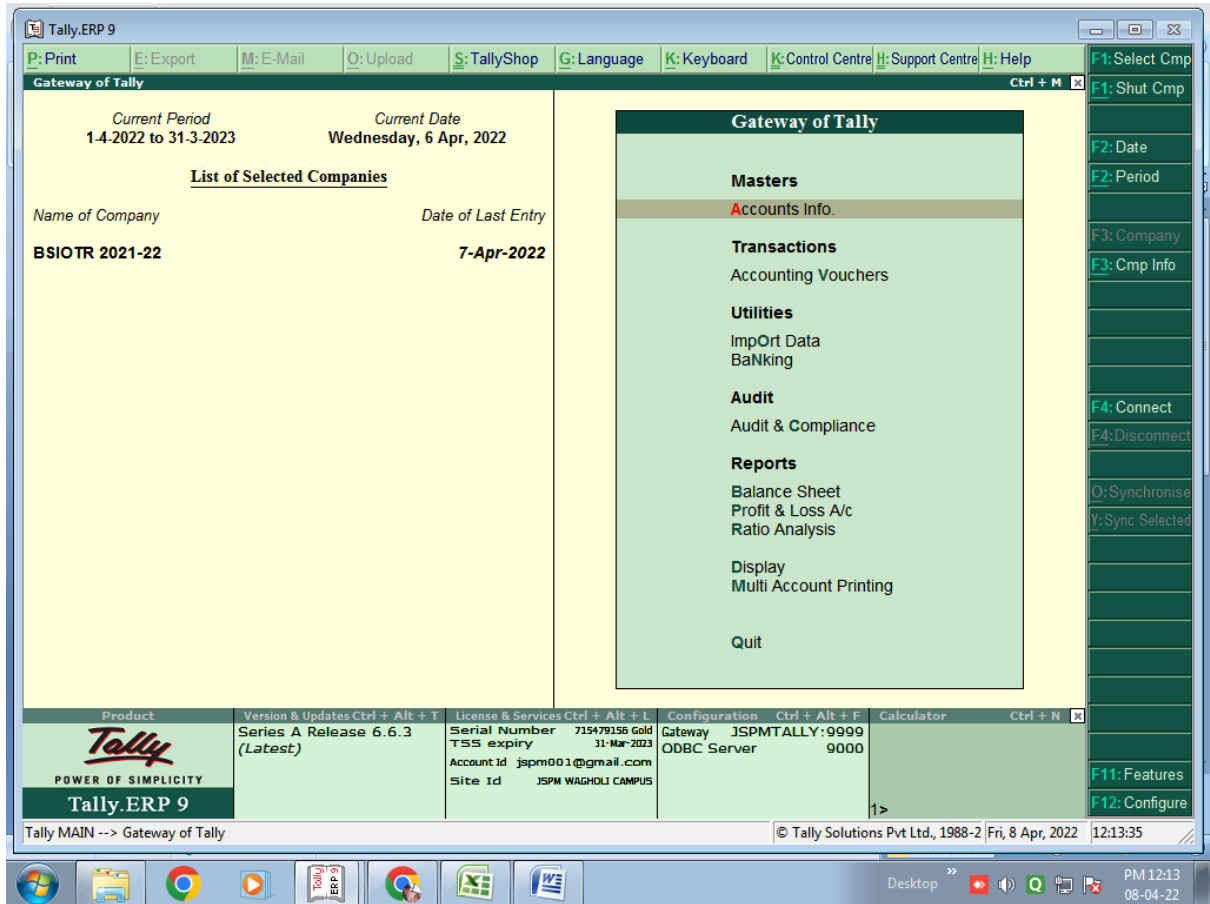

Tally software for Finance and Account

**Department Of Information Technology and Computer Engg**

Academic Year: 2021-22  
**Software List**

**System Software:**

**1) Windows 10**

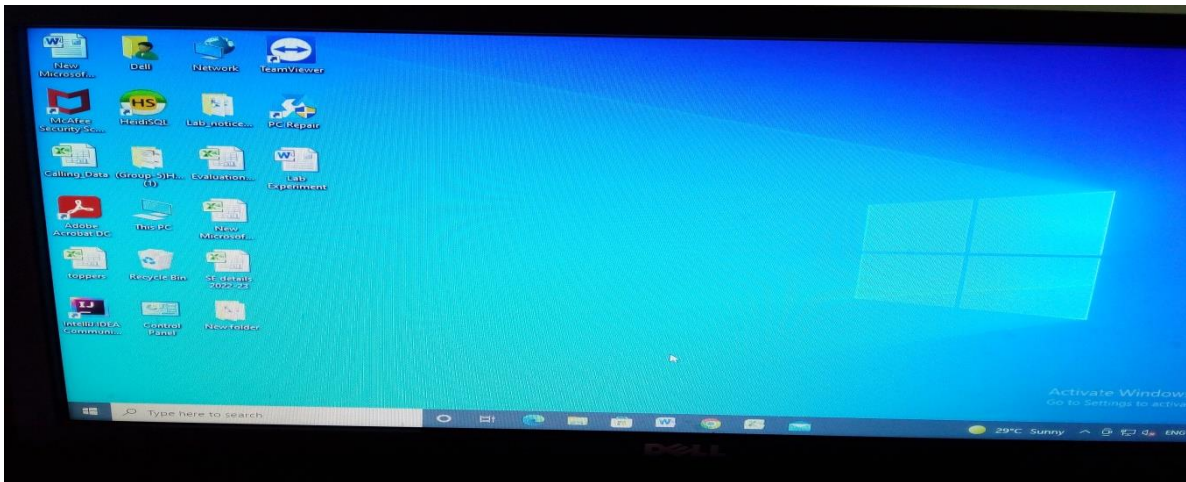

**2)Ubuntu 18.4**

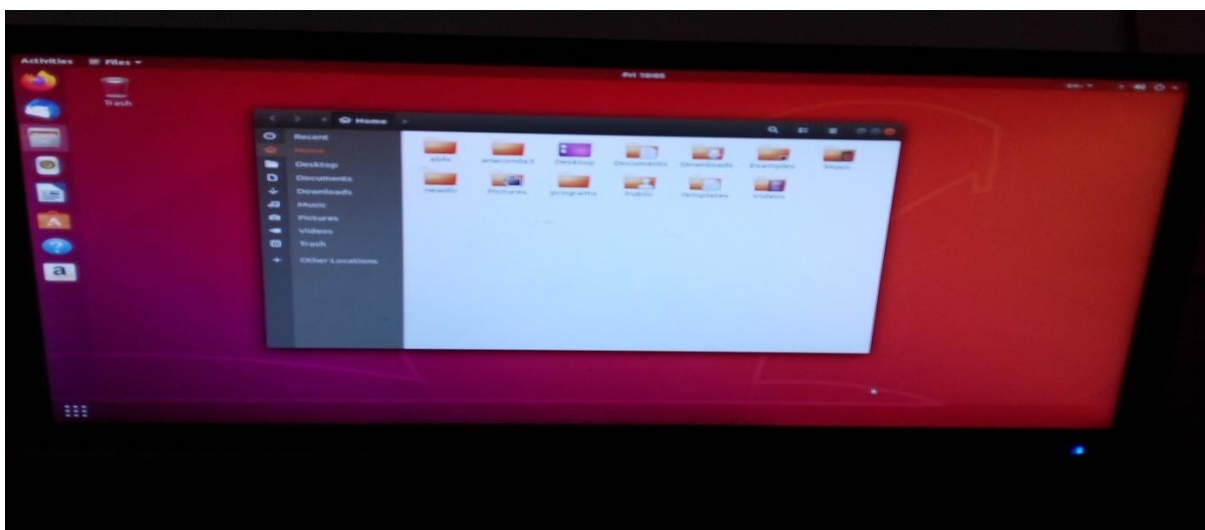

# Application Software:

## 1) Turbo C++:



## 2) Microsoft Visual Code 1.66:

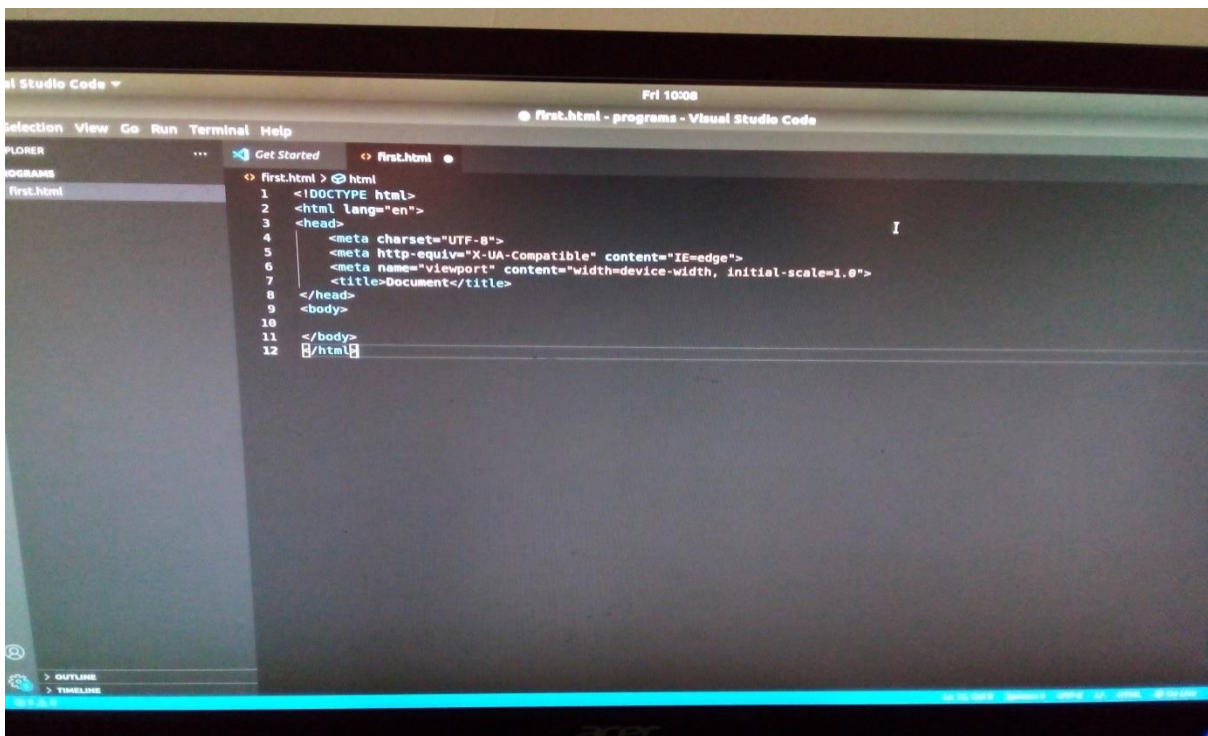

### 3) Microsoft Office:

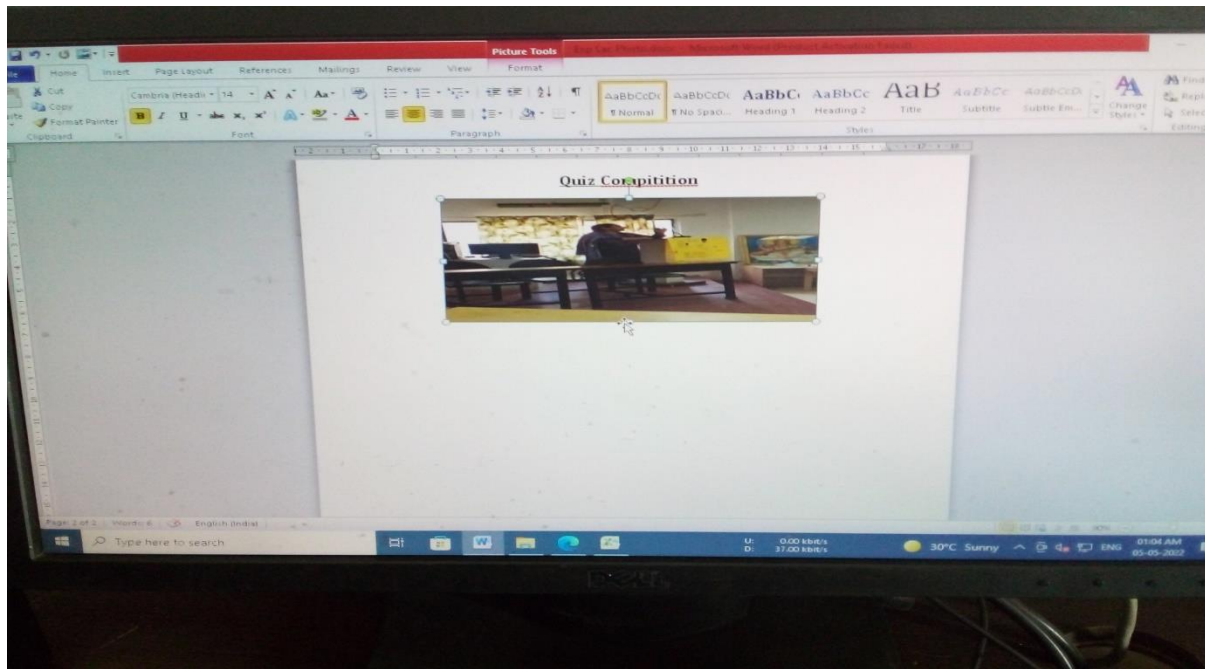

### 4) Microsoft Excel:

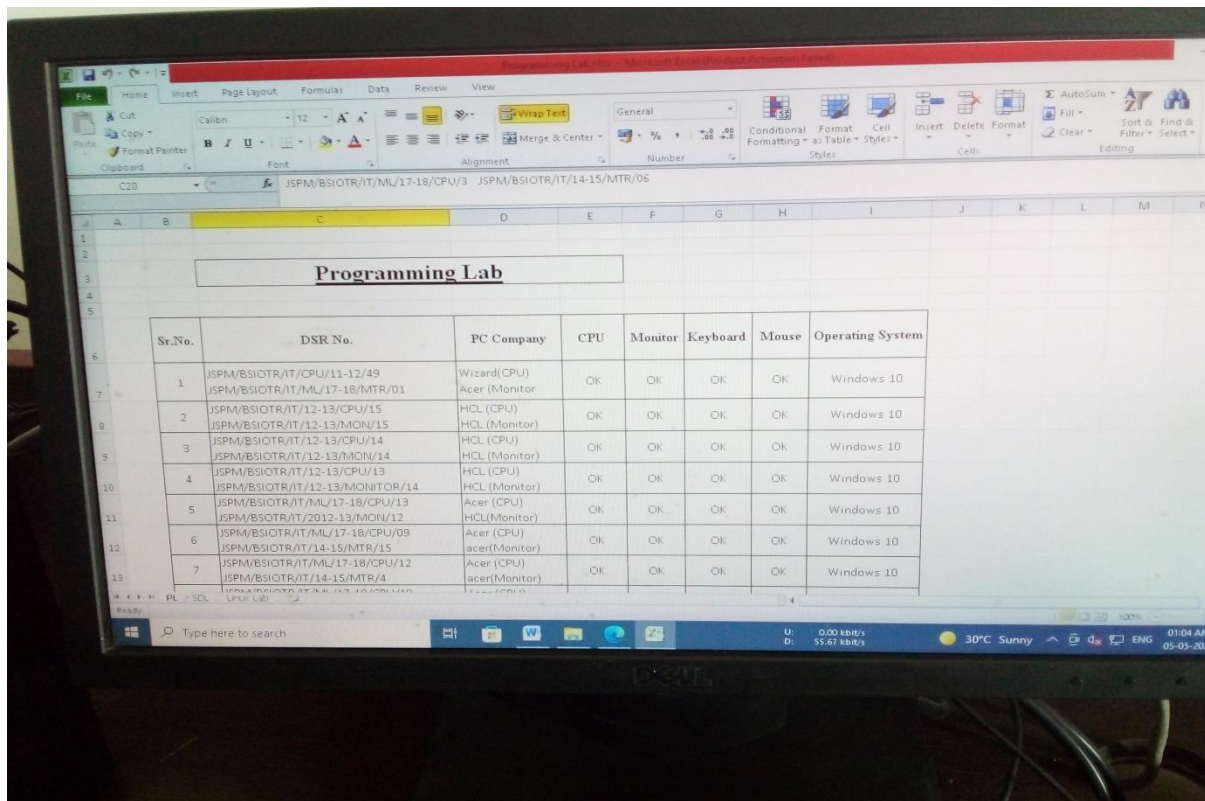

## 5) Pycharm (Python):

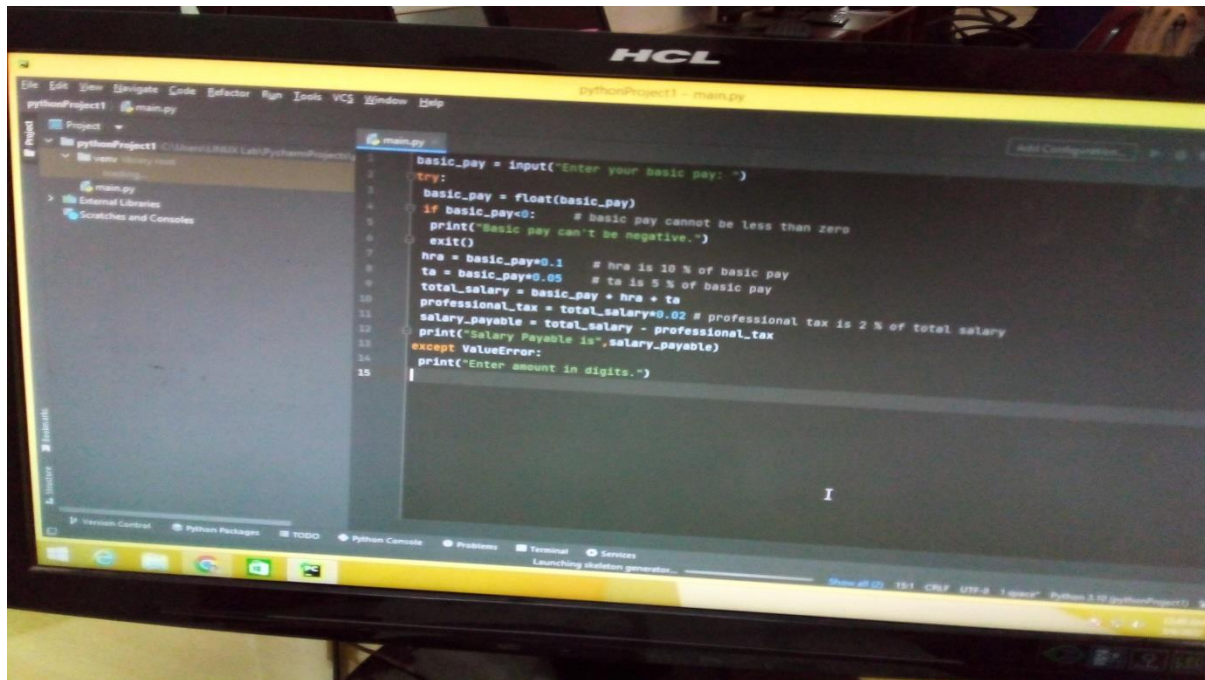

## 6) Adobe Acrobat Reader:

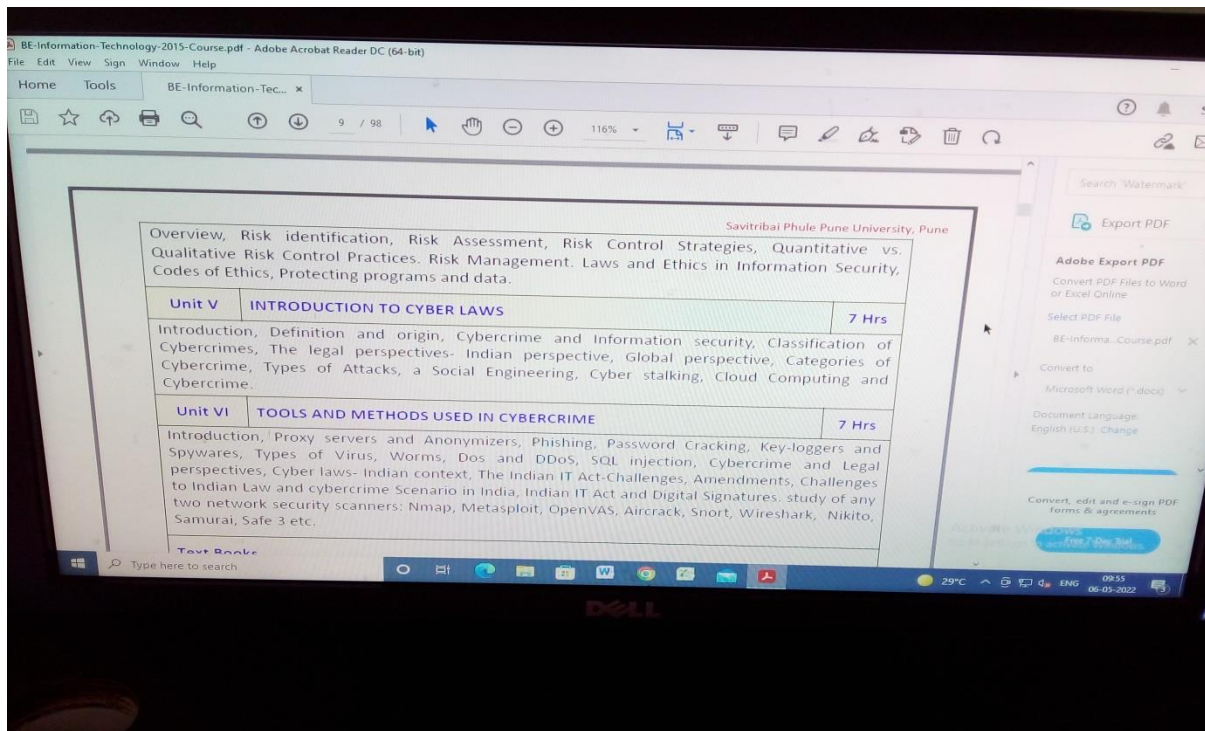

## 7) MySQL database:

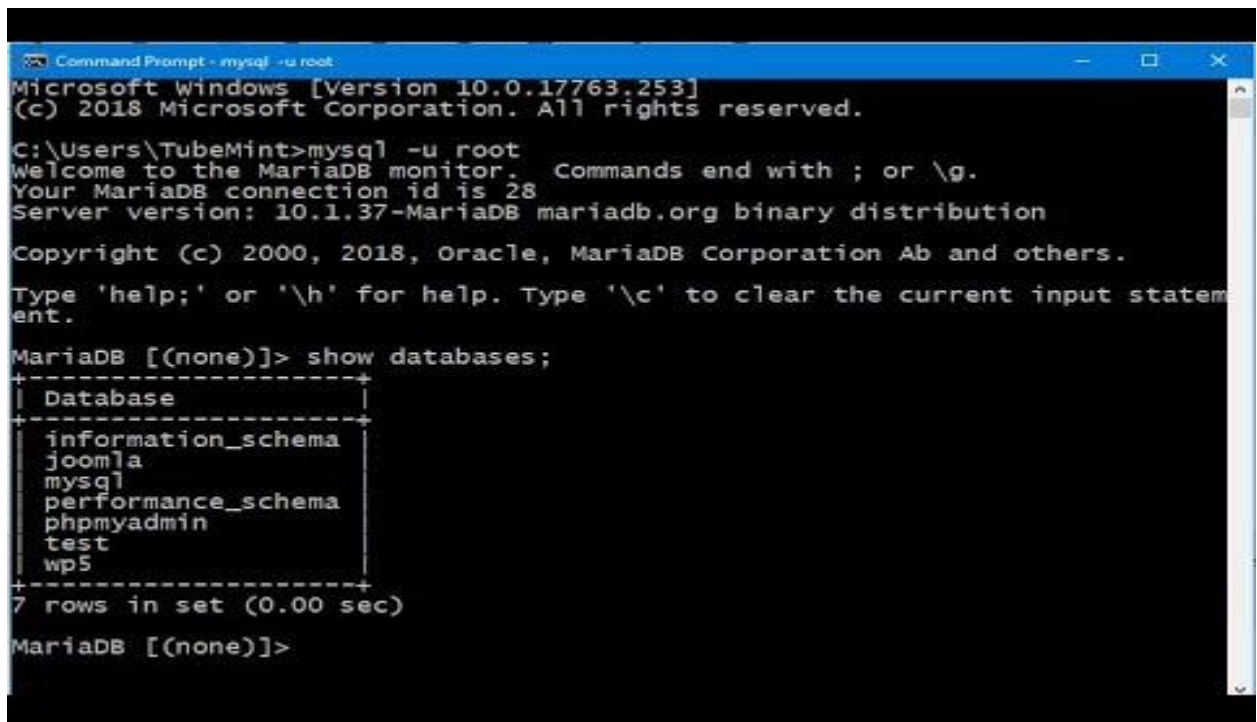

```
Command Prompt - mysql -u root
Microsoft Windows [Version 10.0.17763.253]
(c) 2018 Microsoft Corporation. All rights reserved.

C:\Users\TubeMint>mysql -u root
Welcome to the MariaDB monitor.  Commands end with ; or \g.
Your MariaDB connection id is 28
Server version: 10.1.37-MariaDB mariadb.org binary distribution

Copyright (c) 2000, 2018, Oracle, MariaDB Corporation Ab and others.

Type 'help;' or '\h' for help. Type '\c' to clear the current input statement.

MariaDB [(none)]> show databases;
+-----+
| Database |
+-----+
| information_schema |
| joomla |
| mysql |
| performance_schema |
| phpmyadmin |
| test |
| wp5 |
+-----+
7 rows in set (0.00 sec)

MariaDB [(none)]>
```

# Department of Mechanical Engineering Software's available

## 1. Ansys Output

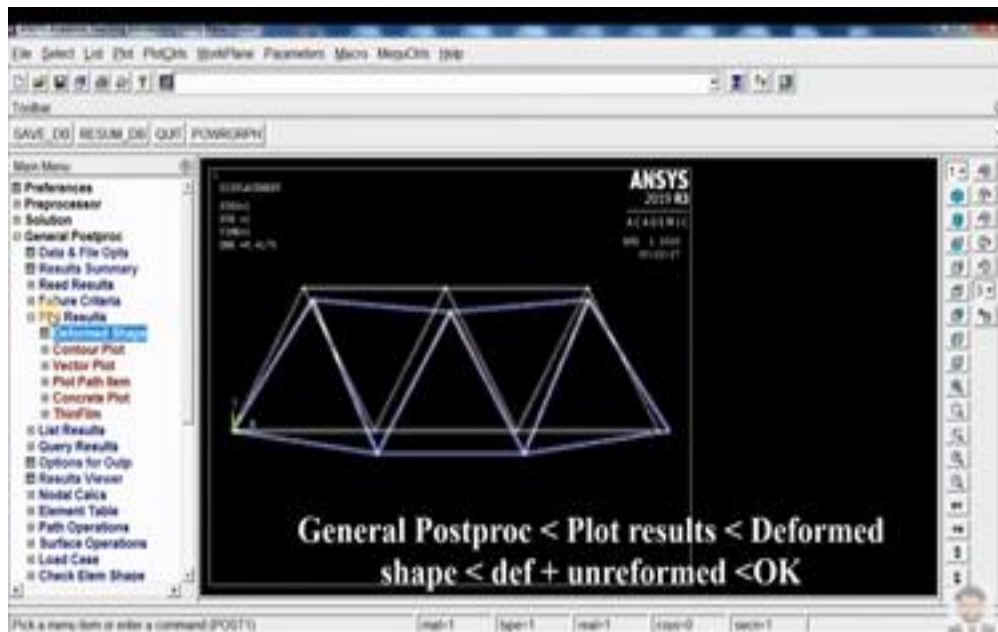
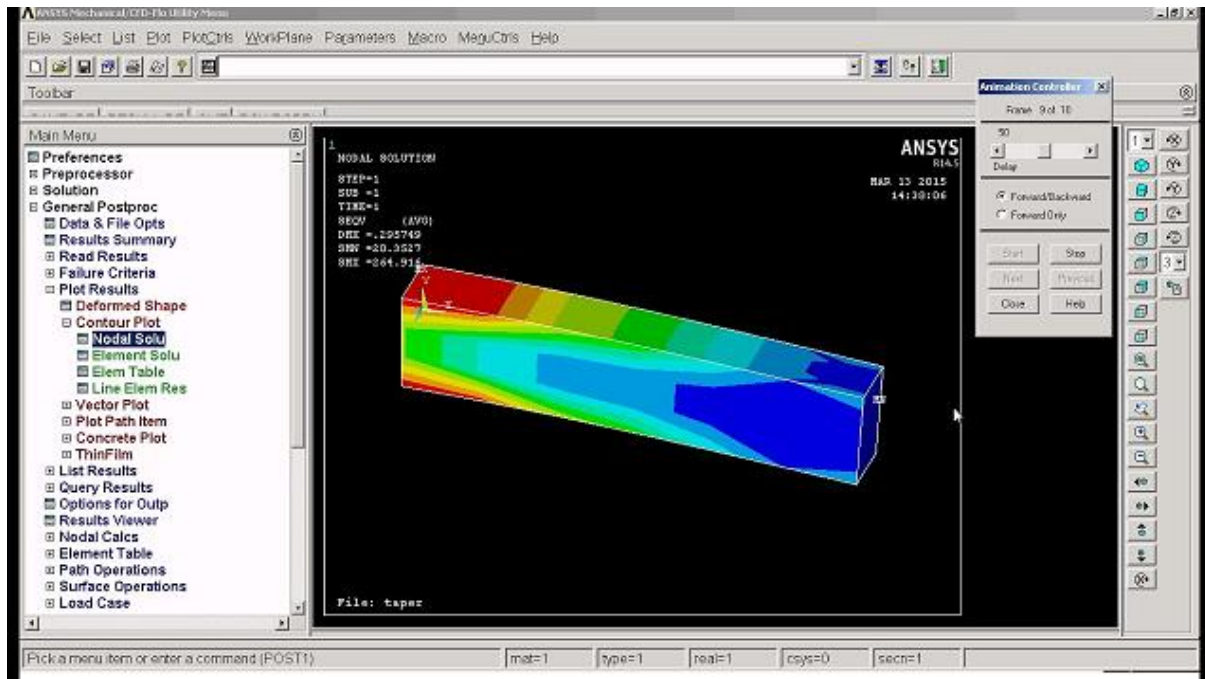





## 2. Autocad output

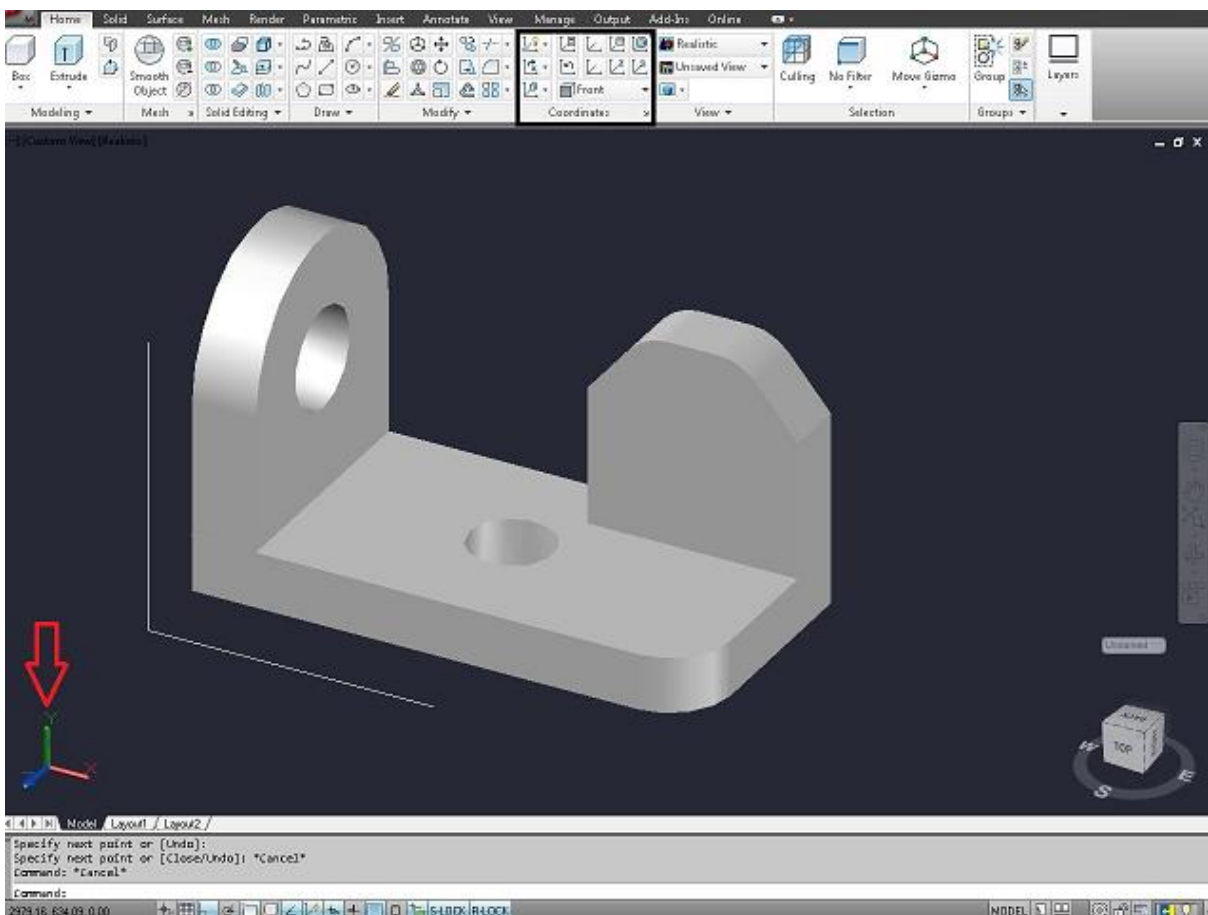
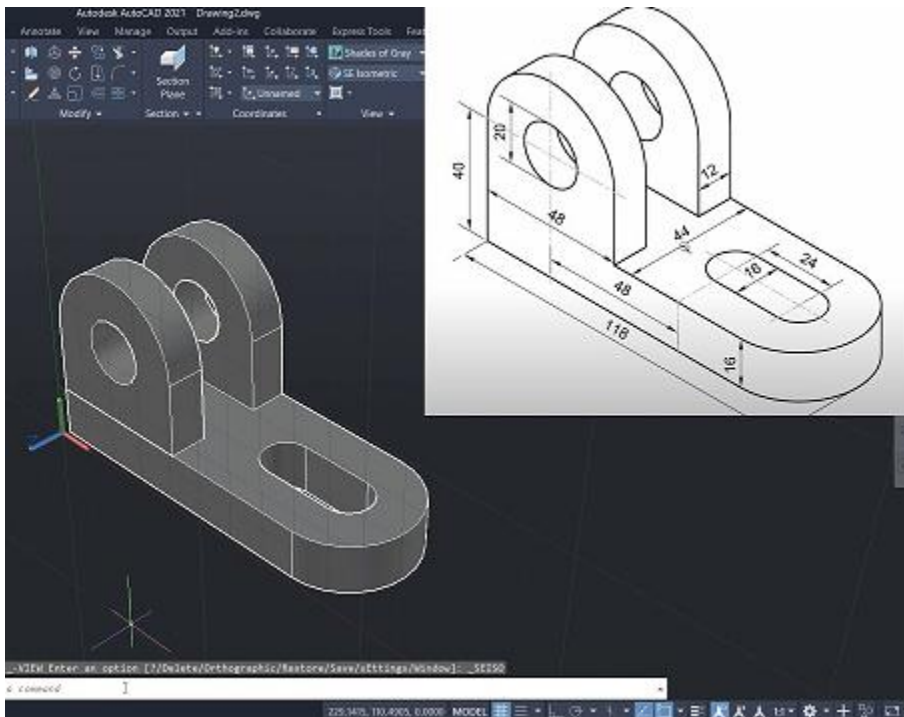

### 3. CAD Feko

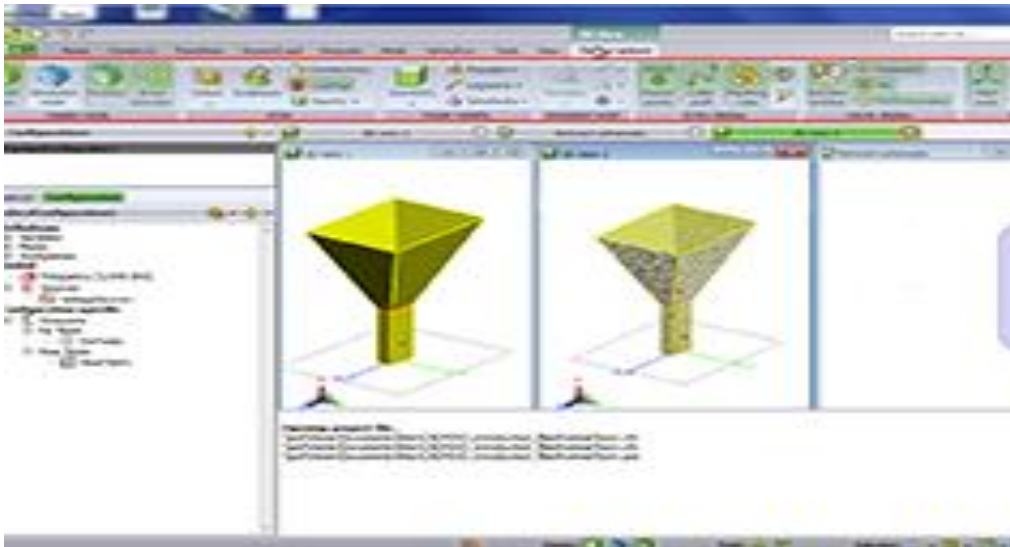

### 4. Creo

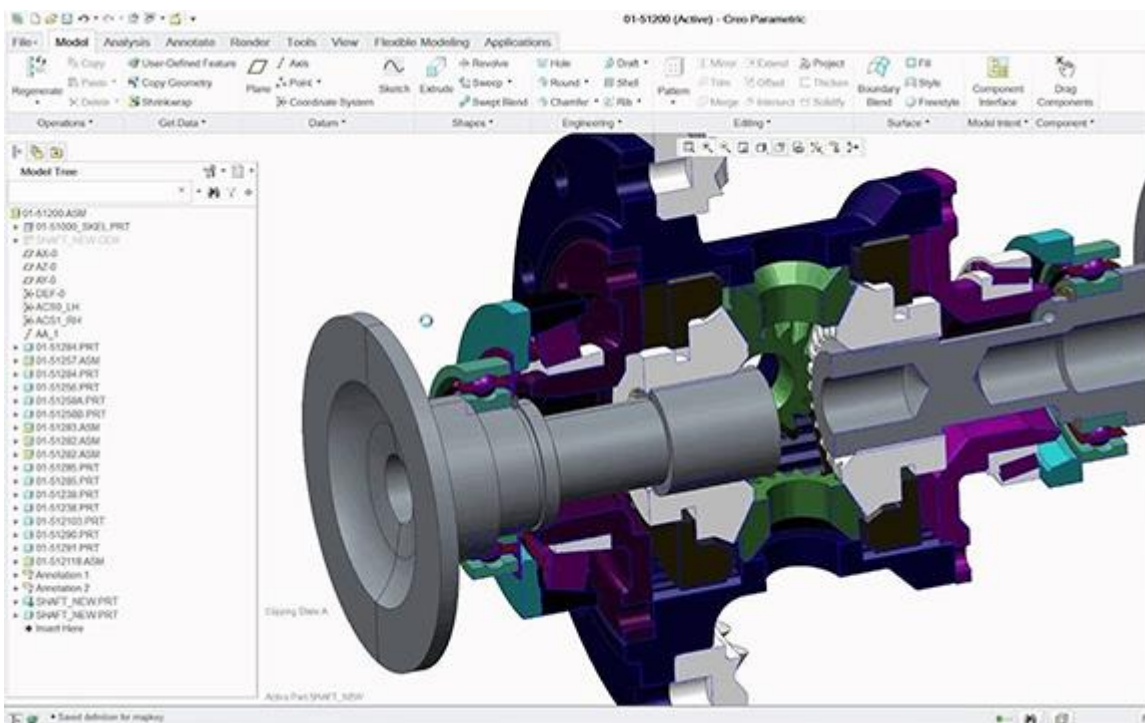

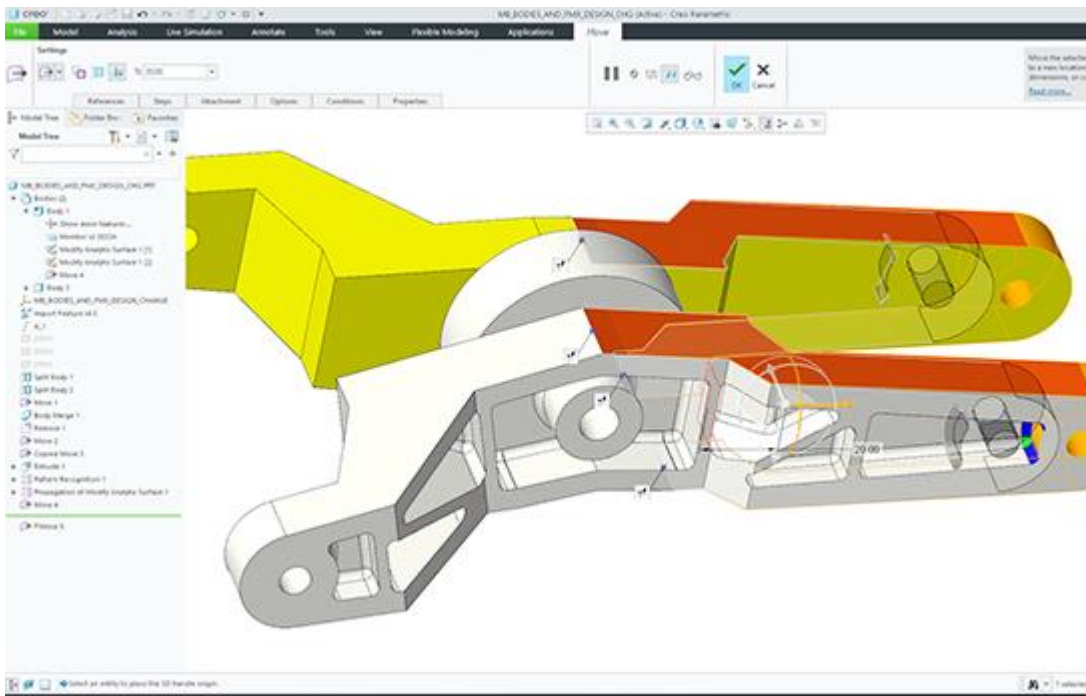

## 5. Matser Cam

